

DOOR CLIPS

TOP SELLING ASSORTMENT

DOOR HANDLE LINKAGE RETAINING CLIPS 717701					
	Zebra 500 Pontiac LeMans 1981-01 OE M 9012389 716640		Ford Products 1989-01 OE F 647-541932A 716644		General Motors 1986-01 Right Hand OE GM 20331-49 716647
	Mazda 4000 Right Hand OE M 9927-80-404 716650		Chrysler Right Side OE M 3454220 717707		Chry, Dodge, Plymouth Right Side OE M 3454221 717709
	Chrysler & GMC Vans 140Pound Range OE M 3009739 469716 717713		General Motors Cars 140Pound Range OE M 3009739 469716 717714		General Motors Cars & Trucks 3/8" Rod Diameter OE M 469716, 200881, 2015834 717715
	Ford Expedition & Navigator 1997-01 OE M 469716 720053		R.H. Style 5/32" Rod Dia. Chrysler Cirrus, Dodge Stratus, Neon, Minivans, Pick-Ups 1995-01 OE M 4658674 720731		L.H. Style 5/32" Rod Dia. Chrysler Cirrus, Dodge Stratus, Neon, Minivans, Pick-Ups 1995-01 OE M 4658675 720732
					General Motors Cars OE M 2049451 1491614 717719

Sosmetal No. 717701
110 pieces • 21 items
12045 plastic tray
See J10-9 for contents



Not all items shown are included in Assortment. Illustrations are actual size unless otherwise noted.

GM Door Lock Rod End Clip
R.H. Style

GM
1986-01
OE: 20633148
20582532

716647 25

GM Linkage Clip

Pontiac
LeMans
1987-01

OE: 90120387

716640 15

IMPORT Door Lock Rod Clip
Right (Passenger) Side
Natural Nylon
5mm Rod Size
Fits 8 5mm Hole

Lexus ES 250
300 & RX 300 &
Toyota Tacoma
1990-01

OE: 69293-12050

724046 5

IMPORT Door Lock Rod Clip
Left (Driver) Side
Yellow Nylon
5mm Rod Size
Fits 8 5mm Hole

Lexus ES 250
300 & RX 300 &
Toyota Tacoma
1990-01

OE: 69293-12060

724047 5

★ Door Latch Locking
Push Rod Clip
R.H. Style

5/32 Rod Size

Chrysler
1972-01
OE: 3454220

717707 25

★ Door Latch Locking
Push Rod Clip
L.H. Style

5/32 Rod Size

Chrysler
1972-01
OE: 3454221

717708 25

★ Door Lock Rod End Clip
R.H. Style

Dodge Omni,
Plymouth
Horizon
1978

OE: 3760130

717709 25

★ Door Lock Rod End Clip
L.H. Style

Dodge Omni,
Plymouth
Horizon
1978

OE: 3760131

717710 25

GM Door Lock Rod
Retaining Clip
R.H. Style

GM
1979-01
OE: 469718
378668
20158344

717716 25

IMPORT Rod End Clip
R.H. Style

Holds 4mm Rods
Fits 6mm Hole

Mazda
OE: 9927-80-404

716650 15

IMPORT Rod End Clip
L.H. Style

Holds 4mm Rods
Fits 6mm Hole

Mazda 323 626 929
1995-76
OE: 9927-80-405

716649 15

GM Door Lock Rod End Clip

.186 Rod Dia.

Chevrolet Vans
1978-01
OE: 3081052
469716

717713 25

Ford Hood Prop Rod Clip
7/32" Rod Dia.

Various
Ford
Models
1991-75

OE: D5ZZ-16828A, B

717183 12

Ford Door Lock
Rod End Clip

5/32"
Rod Dia.

Ford
1986-01

OE: 390523-S,
E6AZ-5421952-A

716644 10

★ Hood Prop Rod
& Door
Lock Clip

5/32"
Rod Dia.

AMC
1970-69
Chrysler

OE: 2945108R, 2945109L,
4003672R, 4003673L

717653 10pairs

GM Door Lock Rod End Clip

.156 Rod Dia.
140P. R.

GM Cars
1978-01
OE: 20008799

717714 25

GM Door Lock Rod End Clip

.156 Rod Dia.
80P. R.

GM Cars
1978-01
OE: 20008798

717715 25

★ Door Lock Rod End Clip
R.H. Style
4mm
Rod Dia.
6mm
Hole Dia.

Chry. Cirrus, Dodge Stratus,
Plymouth Neon, Minivans,
Pick-Ups 1995-01
OE: 4658674

720731 12

★ Door Lock Rod End Clip
L.H. Style
4mm
Rod Dia.
6mm
Hole Dia.

Chry. Cirrus, Dodge Stratus,
Plymouth Neon, Minivans,
Pick-Ups 1995-01
OE: 4658675

720732 12



UNIVERSAL &
MISCELLANEOUS

DOOR CLIPS

Illustrations are actual size unless otherwise noted.







































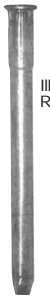

<p>IMPORT</p> <p>Door Lock Rod Clip Right (Passenger) Side Natural Nylon 5mm Rod Size Fits 7mm Hole Lexus ES300 2001-97 Toyota Camry, Celica, Corolla, Echo, Highlander, MR2, RAV4, Tundra & 4-Runner 1994-0n OE: 69293-12030</p> <p>724051 5</p>	<p>IMPORT</p> <p>Door Lock Rod Clip Left (Driver) Side Yellow Nylon 5mm Rod Size Fits 7mm Hole Lexus ES300 2001-97 Toyota Camry, Celica, Corolla, Echo, Highlander, MR2, RAV4, Tundra & 4-Runner 1994-0n OE: 69293-12040</p> <p>Illustration Reduced</p> <p>724052 5</p>	<p>★</p> <p>Door Lock Rod Clip L.H. Side Sliding Door Plastic 5mm Rod Size M7 Hole 3mm P.R. Dodge Full Size 'B' Vans 1997-0n</p> <p>723082 5</p>	<p>IMPORT</p> <p>Hood Prop Rod Clip</p> <p>Acura Integra 1990-86 OE: 91501-SD2-003</p> <p>717649 6</p>
<p>Ford</p> <p>Door Lock Rod End Clip Two Piece Fold Over</p> <p>Ford & Mercury 1986-0n</p> <p>OE: E6DZ-5421952-A, E83Z-5421952-B</p> <p>716643 5</p>	<p>Ford</p> <p>Door Lock Rod Clip 4.8mm Rod Dia., Threaded</p> <p>Ford Expedition & Navigator 1997-0n</p> <p>Illustration Reduced</p> <p>720593 5</p>	<p>GM</p> <p>Door Lock Rod Clip</p> <p>GMCars & Trucks 1996-0n</p> <p>OE: 1662999Q, 1667598Q</p> <p>Illustration Reduced</p> <p>721051 10</p>	<p>Ford</p> <p>Door Lock Rod Clip</p> <p>Ford Contour, Taurus & Mercury Mystique & Sable 1996-0n</p> <p>Illustration Reduced</p> <p>721049 1</p>
<p>GM</p> <p>Door Lock Rod Ferrule Polished Stainless Steel</p> <p>13/16" O.D.</p> <p>GMTrucks 1975-0n OE: 330485</p> <p>720995 12</p>	<p>Ford</p> <p>Door Latch Rod Guide Plastic M13.5 Hole 22.75 x 36.0mm Flange 1.3-1.5mm P. R. Ford Taurus & Mercury Sable 1978-0n</p> <p>OE: F8DZ-54265A99-AA</p> <p>Illustration Reduced</p> <p>723343 7</p>	<p>GM</p> <p>Door Lock Striker Bolt Assembly w/ PVC Plastic Bushing 1/2" -13 Thread 2-1/4" O/L GMCars & Trucks 1991-73 OE: 9601750</p> <p>Illustration Reduced</p> <p>724042 1</p>	<p>Ford</p> <p>Door Glass Bracket Attaching Spacer, Plastic</p> <p>BEFORE SET AFTER SET</p> <p>2step bushing. When compressed, engages glass for a secure attachment. Ford Focus & Lincoln LS 2000-0n OE: XW4Z-54234A44-AA</p> <p>Illustration Reduced</p> <p>723291 5</p>
<p>GM</p> <p>Front Door Clip Outside Handle Spring</p> <p>GM 1956-0n OE: 9711304, 321519BS, 12337868, 3998009</p> <p>717718 25</p>	<p>GM</p> <p>Door Lock Clip</p> <p>GMCars 1955-0n Chev. GMC Trucks 1982-0n</p> <p>OE: 4234483Q 12337868, 14051674</p> <p>717719 25</p>	<p>GM</p> <p>Front & Rear Door Striker Bushing</p> <p>3/4" Length 9/16" I.D. 23/32" O.D.</p> <p>GMCars 1979-77</p> <p>717574 4</p>	
<p>IMPORT</p> <p>Window Screw Grommet w/Sealer Gasket</p> <p>#6 Screw Size</p> <p>Mazda MPV 1998-0n OE: LA01-50-6A8A</p> <p>720935 10</p>		<p>★</p> <p>Window to Regulator Grommet, Plastic M12.7 Hole, M6.3 Screw 3.5mm Glass Thickness</p> <p>Dodge Neon 2000-0n</p> <p>OE: 5008055AA</p> <p>723075 7</p>	



UNIVERSAL &
MISCELLANEOUS

DOOR HINGE PINS & BUSHINGS

Illustrations are actual size unless otherwise noted.

  <p>Door Hinge Bushing Sintered Bronze 5/16" I.D. 13/32" O.D. 9/32" HT. Ford (rear door) 1992-79 GM19326n GM'C' & 'K' Truck 1993-73 OE: D1AZ-6522841A, 9721917</p>  <p>717166 25</p>	 <p>Door Hinge Bushing Sintered Bronze 3/8" I.D. 1/2" O.D. 15/32" HT. GM'H Bodies 1980-42 OE: 9822198</p>  <p>717189 25</p>	 <p>Door Hinge Bushing Sintered Bronze 5/16" I.D. 1/2" O.D. 23/64" HT. GM (thick) 'A', 'B', 'C', 'F', 'J', 'X' & 'Y' Bodies 19686n OE: 20429500</p>  <p>717238 25</p>	 <p>Door Hinge Bushing Sintered Bronze 5/16" I.D. 1/2" O.D. 23/64" HT. GM Trucks & Cars used on hinges w/worn enlarged holes 19766n OE: 20345137, 97616926</p>  <p>717385 25</p>
 <p>Door Hinge Bushing Sintered Bronze 5/16" I.D. 31/64" O.D. 9/32" HT. Ford (front door) 19736n OE: D90Z-6522841A</p>  <p>717387 25</p>	 <p>Side Door Upper Hinge Bushing Splined O.D. 11/32" I.D., 1/2" O.D. 23/64" HT. 43/64" Flange O.D. GM Trucks 'C-K' Models 19886n OE: 12338074, 15691493, 15964971, 16632193</p>  <p>717363 12</p>	 <p>Side Door Lower Hinge Bushing Sintered Bronze 25/64" I.D. 17/32" O.D. 23/64" HT. 11/16" Flange O.D. GM Trucks 'C-K' Models 19886n OE: 15562609, 15964972, 16632192</p>  <p>717364 12</p>	 <p>Door Hinge Pin Zinc & Yellow 11/32" Dia. 4-5/32" Lgth. 15/32" Head Dia. GM Astro Van, Safari Van & S-10 19826n OE: 12338015, 14066728</p>  <p>717256 5</p>
 <p>Door Pin 5/16" Dia. 4-1/8" Lgth. GM All exc. 'H' Bodies 1977-76 GM 'A', 'B', 'C' & 'F' Bodies 1992-78 GM Trucks 'C', 'K' & 'G' Bodies 1992-73 OE: 6271989, 20046147</p>  <p>717235 25</p>	 <p>Door Pin 5/16" Dia. 4" Lgth. GM 'X' Bodies 1984-80 GM 'A', 'F', & 'J' Bodies 1992-82 GM 'T' Bodies (rear door) 1992-78 OE: 20043351</p>  <p>717236 25</p>	 <p>Door Pin 5/16" Dia. 2" Lgth. GM 'T' Bodies (front door) 1981-76 OE: 20043351</p>  <p>717237 25</p>	 <p>Door Pin 1/4" Dia. 2-5/8" Lgth. Dodge, Plymouth Vans, cargo doors (side or rear) 19706n OE: 6028993, 6032975</p>  <p>717389 12</p>
 <p>Door Pin 5/16" Dia. 2-13/16" Lgth. Buick Skylark, Chev. Nova, Olds. Omega & Pon. Phoenix 1979-71 OE: 9806723</p>  <p>717390 25</p>	 <p>Door Pin 11/32" Dia. 5-1/4" Lgth. GM 'C' & 'K' Trucks 19886n OE: 1559186Q, 15967691, 15691595, 88891731</p>  <p>717397 12</p>	 <p>Door Hinge Pin 11/32" Dia. 4-1/8" Lgth. GM 'S' & 'T' Trucks 19946n OE: 15653790</p>  <p>720999 2</p>	 <p>Door Roller Pin Assembly 9/16" Dia. 5-1/2" Lgth. 3/4" Roller O.D. 5/8" Roller Groove Dia. 19/32" Knurl Dia. GM 'C' & 'K' Light Duty Trucks 19886n</p>  <p>720997 1</p>
 <p>Door Roller Pin Assembly 25/64" Dia. 5-1/16" Lgth. 3/4" Roller O.D. 5/8" Roller Groove Dia. GM 'S' & 'T' Trucks 19946n OE: 15672183</p>  <p>720998 1</p>	 <p>Door Hinge Pin Zinc Plated 11/32" Dia. 3-3/8" Lgth. Ford Mustang 1993-79 Ford Tempo & Mercury 1994-90 Mercury Capri 1986-80 OE: D9ZZ-6643030-AA</p>  <p>721055 10</p>	 <p>Door Pin 1/4" Dia. 2-5/32" Lgth. Chrysler 19806n OE: 6500361</p>  <p>717388 25</p>	 <p>Pin 3/8" Dia. 3-1/8" Lgth. Chrysler Various Models 19846n OE: 4280727</p>  <p>717395 12</p>



UNIVERSAL & MISCELLANEOUS

DOOR HINGE PINS & BUSHINGS

Illustrations are actual size unless otherwise noted.



Door Pin
1/4" Dia.
2-25/32" Lgth.
Chrysler 'K' Body
1984-6n
OE: 6501299

717396 **25**



Door Hinge Spring
GM 'C' & 'K' Series
Pick-Ups
2002-88

717461 **1**



Side Cargo Door Hinge Pin & Bushing Kit
Greaseable
Stainless Steel
GMSavana Van
& Express Van
2006-1996
OE: 31028283
88944360

724168 **1**

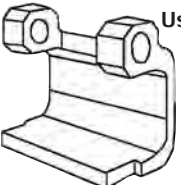

Side Cargo Door Hinge
Use with Pin & Bushing Kit
724168
GMSavana Van & Express Van
2006-1996
OE: N/A

724169 **1**

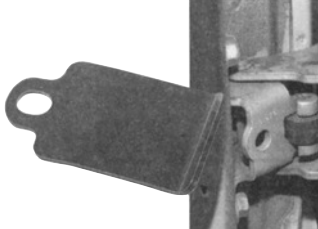

Door Hinge Spring Repair
Restores Ford door check without hinge replacement.
Ford Cars & Trucks
1997-80
Bolts on to hinge to repair weak or broken springs without removing door. Includes hardware to install. Not available separately from the dealer.

716639 **1**

GM Truck Door Hinge Pin & Bushing Repair Kit
Chevrolet Silverado, Suburban & Tahoe & GMC Sierra, Yukon & Yukon XL 2005-99

Why bother with the hassle of cutting and grinding off a worn door hinge and welding on a new one when you can repair the bad hinge in a fraction of the time? With our new Door Hinge Pin & Bushing Repair Kit, fixing sagging doors caused by worn hinges due to pin failure is quick. It's easy. It works. And you don't have to repaint the welded heat flash area. Each kit is designed to repair one hinge and contains two pins made of zinc plated machined cold rolled steel, two self-lubricating brass alloy bushings, two zinc plated nylon insert lock nuts and a zinc plated washer.

Here's how it works:

1. Remove the door from the truck body.
2. Remove the original equipment pin and bushings.
3. Install the bushings into the hinge holes.
4. Install the longer pin into the top hinge hole.
5. Thread on the lock nut.
6. Install the shorter pin into the bottom hinge hole.
7. Place the washer and a nut on the shorter pin.
8. Tighten the nut to pull the pin into place.
9. Slowly tighten both upper and lower lock nuts.
10. Reattach the door to the truck body.

Detailed instructions are included with the kit.

723290 **1**

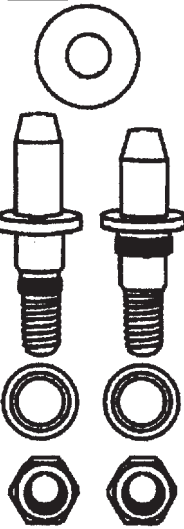

ISO 9001: 2000 CERTIFIED

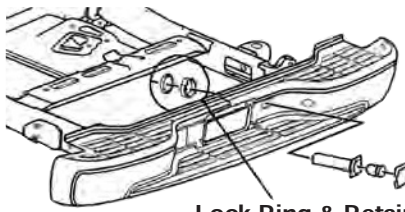

Retainer & Lock Ring for Spare Tire Lock Cylinder Housing
Damaged whenever the bumper is removed
GM 'C' & 'K' Trucks, Sierra, Silverado, Denali, Escalade, Tahoe, Yukon & Suburban
1999-6n
OE: 15040331 & 15769308

724141 **5**

View of Rear Bumper Spare Tire Lock Cylinder Access Door



View of Spare Tire Lock Cylinder Access Door Open

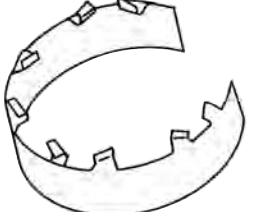

Views From the Back Side of Bumper Cylinder Housing with Sosmetal No. 724141-5 Retainer and Lock Ring in Place

Lock Ring & Retainer

GM

Retainer & Lock Ring for Spare Tire Lock Cylinder Housing
Damaged whenever the bumper is removed
GM 'C' & 'K' Trucks, Sierra, Silverado, Denali, Escalade, Tahoe, Yukon & Suburban
1999-6n
OE: 15040331 & 15769308

724141 **5**

View of Rear Bumper Spare Tire Lock Cylinder Access Door



View of Spare Tire Lock Cylinder Access Door Open



Views From the Back Side of Bumper Cylinder Housing with Sosmetal No. 724141-5 Retainer and Lock Ring in Place

